

Leading Media Products

Multi-Purpose Media



Multi-Purpose Labeling

North America



CONTENTS

MEDIA FOR DESKTOP PRINTERS

- Duratherm II Labels.....3
- Duratherm III Labels.....4
- Duratron II Labels.....5
- Duratron S Film Labels.....6
- Duratron II Gloss Polyester Labels7
- ThermaMAX 1000 Wax Ribbons.....8
- ThermaMAX 2000 Mid-Range Ribbons8
- ThermaMAX 3000 Resin Ribbons8

MEDIA FOR INDUSTRIAL PRINTERS

- Duratherm II Labels.....9
- Duratherm II Tag10
- Duratherm III Labels.....11
- Duratron II Labels.....12
- Duratron II Floodcoated Labels.....13
- Duratron II Tags14
- Duratron II Kimdura Film Labels15
- Duratron II Valeron Film Tags.....16
- Duratron II Gloss Polyester Labels16
- ThermaMAX 1000 Wax Ribbons.....17
- ThermaMAX 2000 Mid-Range Ribbons17
- ThermaMAX 3000 Resin Ribbons17

APPENDIX

- Direct Thermal vs. Thermal Transfer18
- Free Printhead Replacement Program18

MEDIA FOR DESKTOP PRINTERS

Duratherm II Labels

Duratherm II is a non top-coated direct thermal paper that offers high quality, cost-effective printing. This material is recommended for most general-use applications where exposure to chemicals and moisture is not anticipated. Permanent adhesive.

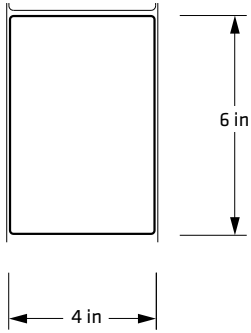

E25726

Size	ID	OD	Part Number	Qty/Roll	Rolls/Ctn	Ctn Weight	Stock/MTO	Suggested Retail Price \$/Roll	\$/M
4" x 6"	1.5"	5"	E25726	439	8	17	Stock	\$18.08	\$41.19



MEDIA FOR DESKTOP PRINTERS

Duratherm III Labels

Duratherm III is a top-coated direct thermal paper that provides enhanced durability for applications where humidity and surface abrasion are a concern. Permanent adhesive.

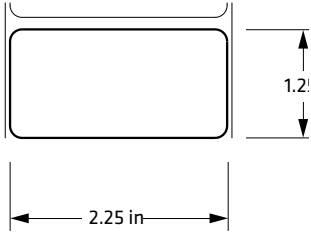

E15532

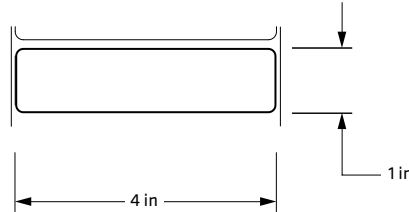

E15534

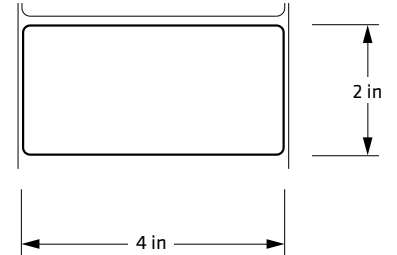

E15535

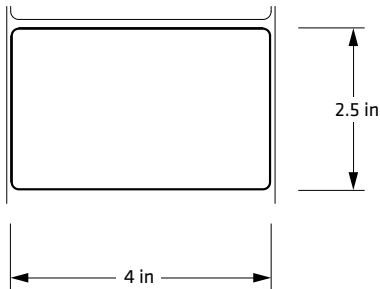

E15536

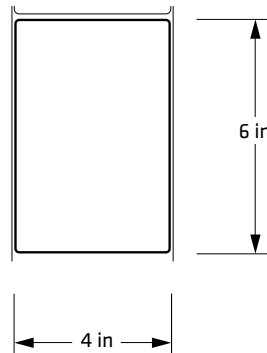

E15539

Size	ID	OD	Part Number	Qty/Roll	Rolls/Ctn	Ctn Weight	Stock/ MTO	Suggested Retail Price \$/Roll	\$/M
2.25" x 1.25"	1.5"	5"	E15532	1793	8	13	Stock	\$11.07	\$6.17
4" x 1"	1.5"	5"	E15534	2391	8	22	Stock	\$19.74	\$8.26
4" x 2"	1.5"	5"	E15535	1265	8	22	Stock	\$19.74	\$15.60
4" x 2.5"	1.5"	5"	E15536	1024	8	22	Stock	\$19.74	\$19.28
4" x 6"	1.5"	5"	E15539	439	8	22	Stock	\$19.74	\$44.97



MEDIA FOR DESKTOP PRINTERS

Duratran II Labels

Duratran™ II is a top-coated thermal transfer paper that demonstrates excellent print quality with the TMX1407 ribbon. This product is recommended where moderate abrasion, heat or sunlight are present. Permanent adhesive.

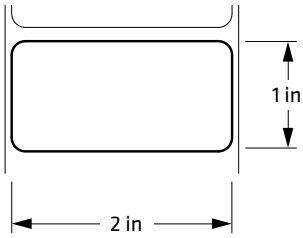

E25751

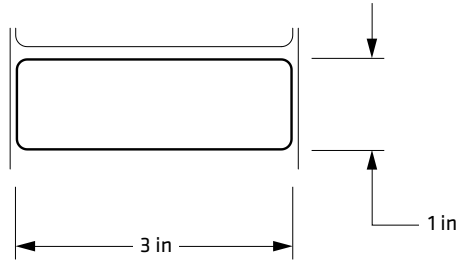

E17012

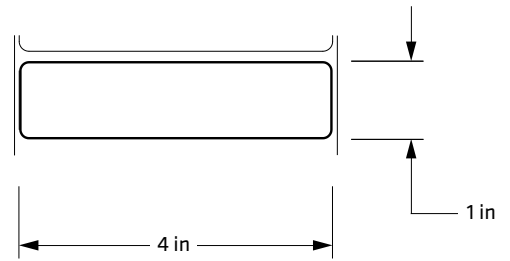

E15522

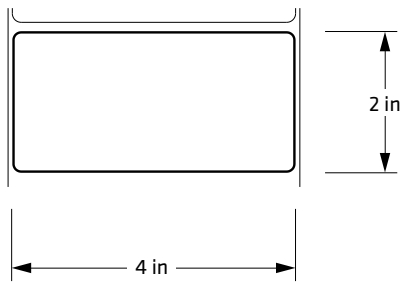

E15523

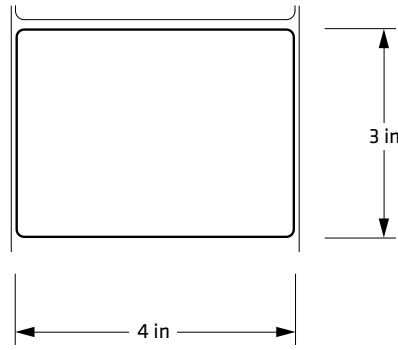

E25752

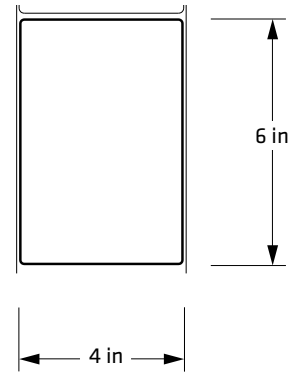

E15527

Size	ID	OD	Part Number	Qty/Roll	Rolls/Ctn	Ctn Weight	Stock/ MTO	Suggested Retail Price		PC43t / PF8-1/2" Core Ribbon	PC43t / PF8-1" Core Ribbon
								\$/Roll	\$/M		
2" x 1"	1.5"	5"	E25751	2,391	8	11	MTO	\$18.21	\$7.61	11043304	11232211
3" x 1"	1.5"	5"	E17012	2,391	8	17	Stock	\$11.59	\$4.85	11043304	11233011
4" x 1"	1.5"	5"	E15522	2,391	8	21	Stock	\$15.45	\$6.46	11044304	11234012
4" x 2"	1.5"	5"	E15523	1,265	8	21	Stock	\$15.45	\$12.21	11044304	11234012
4" x 3"	1.5"	5"	E25752	860	8	21	MTO	\$42.67	\$49.62	11044304	11234012
4" x 6"	1.5"	5"	E15527	439	8	21	Stock	\$15.45	\$35.18	11044304	11234012



MEDIA FOR DESKTOP PRINTERS

Duratran S Film Labels

A 3 mil thick polypropylene thermal transfer label at an attractive price point. The matte face stock offers excellent print quality and moisture resistance; recommended for up to 6 months outdoor exposure. Demonstrates excellent print quality when printed with the TMX2202 Mid-Range ribbon. Permanent adhesive.

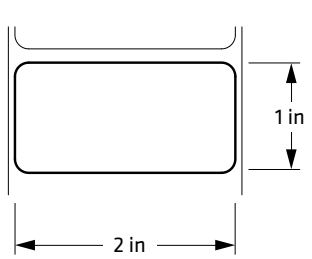

E25754

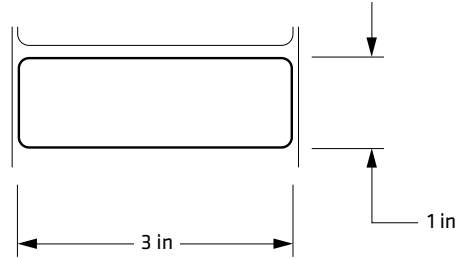

E25755

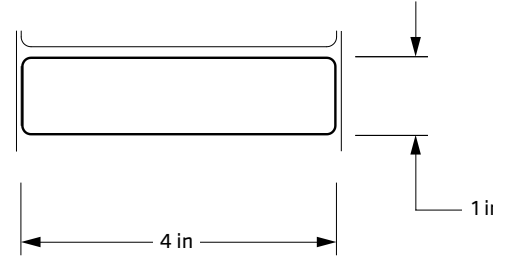

E25756

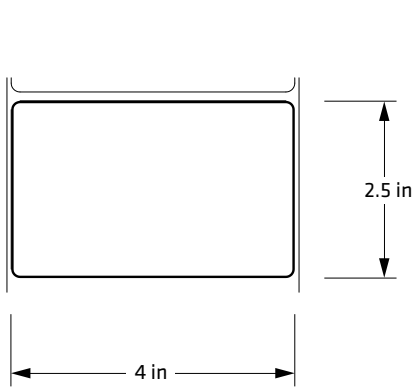

E25757

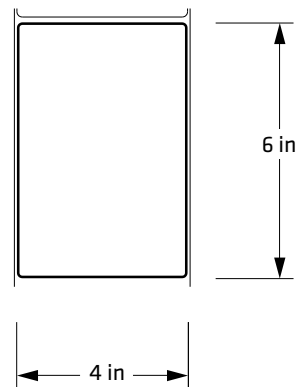

E25758

Size	ID	OD	Part Number	Qty/Roll	Rolls/Ctn	Ctn Weight	Stock/ MTO	Suggested Retail Price		PC43t / PF8-1/2" Core Ribbon	PC43t / PF8-1" Core Ribbon
								\$/Roll	\$/M		
2" x 1"	1.5"	5"	E25754	1,911	8	17	MTO	\$23.69	\$12.40	12042504	12232311
3" x 1"	1.5"	5"	E25755	1,911	8	17	MTO	\$30.10	\$15.75	12043204	12233111
4" x 1"	1.5"	5"	E25756	1,911	8	17	MTO	\$47.72	\$24.97	12044304	12234012
4" x 2.5"	1.5"	5"	E25757	819	8	17	MTO	\$47.72	\$58.26	12044304	12234012
4" x 6"	1.5"	5"	E25758	351	8	17	MTO	\$47.72	\$135.95	12044304	12234012



MEDIA FOR DESKTOP PRINTERS

Duratran II Gloss Polyester Labels

A high-gloss, top-coated polyester label with exceptional print quality. Excellent tear, smear and abrasion resistance; highly moisture and heat resistant. Product is UL recognized when printed with Intermec TMX3201 and TMX3202 ribbons. High-tack adhesive.

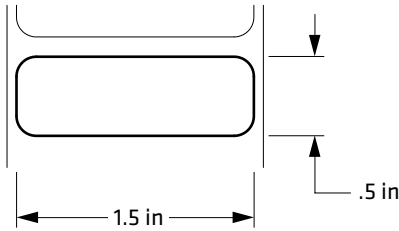

E25745

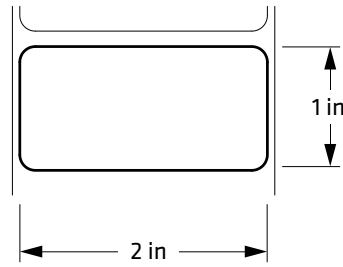

E22233

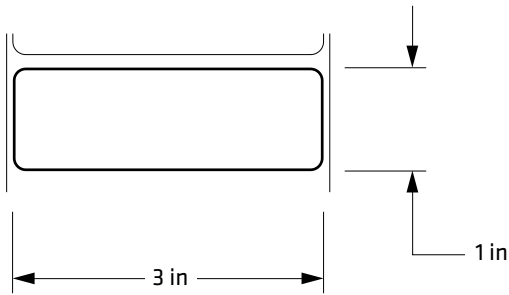

E25746

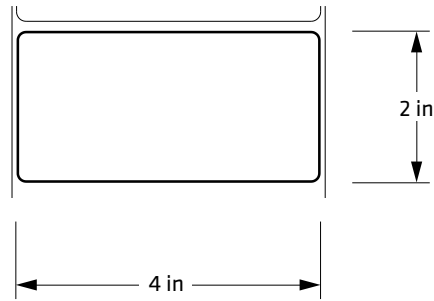

E25747

Size	ID	OD	Part Number	Qty/Roll	Rolls/Ctn	Ctn Weight	Stock/ MTO	Suggested Retail Price \$/Roll	\$/M	PC43t / PF8-1/2" Core Ribbon	PC43t / PF8-1" Core Ribbon
1.5" x 0.5"	1.5"	5"	E25745	4,304	8	10	MTO	\$31.92	\$7.42	13042504	13632111
2" x 1"	1.5"	5"	E22233	2,391	8	12	Stock	\$25.58	\$10.70	13042504	13632111
3" x 1"	1.5"	5"	E25746	2,391	4	20	MTO	\$52.49	\$21.95	13044304	13634012
4" x 2"	1.5"	5"	E25747	1,265	4	26	MTO	\$33.11	\$26.17	13044304	13634012

MEDIA FOR DESKTOP PRINTERS

ThermaMAX 1000 Wax Ribbons

A general-purpose, smear-resistant wax ribbon providing good durability when printing on Duratran™ II Papers and Tags. Ribbons are wound coated side out.

Size	Length	Part Number	Qty/Ctn	Ctn Weight	Stock/MTO"	Suggested Retail Price		Printer
						\$/Roll	\$/Carton	
2.35"	10800"	11232211	36	17	Stock	\$8.58	\$308.88	PF8-1"
3.1"	10800"	11233011	24	21	Stock	\$11.32	\$271.68	PF8-1"
3.27"	3588"	11043304	24	11	Stock	\$5.00	\$120.00	PC41, PF8-1/2"
4.1"	10800"	11234012	24	19	Stock	\$14.97	\$359.28	PF8-1"
4.33"	3588"	11044304	12	7	Stock	\$6.62	\$79.44	PC41, PF8-1/2"

ThermaMAX 2000 Mid-Range Ribbons

A mid-range ribbon that provides enhanced abrasion/smear resistance and high image quality when used with Duratran II coated papers and across the Intermec Mid-Range Film product line. Ribbons are wound coated side out.

Width	Length	Part Number	Qty/Ctn	Ctn Weight	Stock/MTO"	Suggested Retail Price		Printer
						\$/Roll	\$/Carton	
2.35"	10800"	12232311	24	9	Stock	\$16.06	\$385.44	PF8-1"
2.5"	3588"	12042504	36	9	Stock	\$6.70	\$241.20	PC41, PF8-1/2"
3.15"	10800"	12233111	24	10	MTO	\$21.52	\$516.48	PF8-1"
3.27"	3588"	12043204	36	11	Stock	\$8.78	\$316.08	PC41, PF8-1/2"
4.1"	10800"	12234012	24	19	MTO	\$28.00	\$672.00	PF8-1"
4.33"	3588"	12044304	18	7	Stock	\$11.62	\$209.16	PC41, PF8-1/2"

ThermaMAX 3000 Resin Ribbons

A high quality resin ribbon for applications that require the optimum level of smear and abrasion resistance. Excellent imaging and performance across the Intermec Ultra-Durable Film product line. Ribbons are wound coated side out. UL Recognized when used with Intermec Duratran II Gloss Polyester Labels.

Width	Length	Part Number	Qty/Ctn	Ctn Weight	Stock/MTO"	Suggested Retail Price		Printer
						\$/Roll	\$/Carton	
2.36"	10800"	13632111	24	12	Stock	\$19.16	\$459.84	PF8-1"
2.5"	3588"	13042504	24	7	Stock	\$11.06	\$265.44	PC41, PF8-1/2"
3.1"	10800"	13633111	24	15	MTO	\$30.93	\$742.32	PF8-1"
3.1"	3588"	13633136	24	7	MTO	\$13.71	\$329.04	PC41, PF8-1/2"
4.1"	10800"	13634012	24	14	Stock	\$65.28	\$1566.72	PF8-1"
4.33"	3588"	13044304	24	7	Stock	\$19.14	\$459.36	PC41, PF8-1/2"



MEDIA FOR INDUSTRIAL PRINTERS

Duratherm II Labels

Duratherm II is a non top-coated direct thermal paper that offers high quality, cost-effective printing. This material is recommended for most general-use applications where exposure to chemicals and moisture is not anticipated. Permanent adhesive.

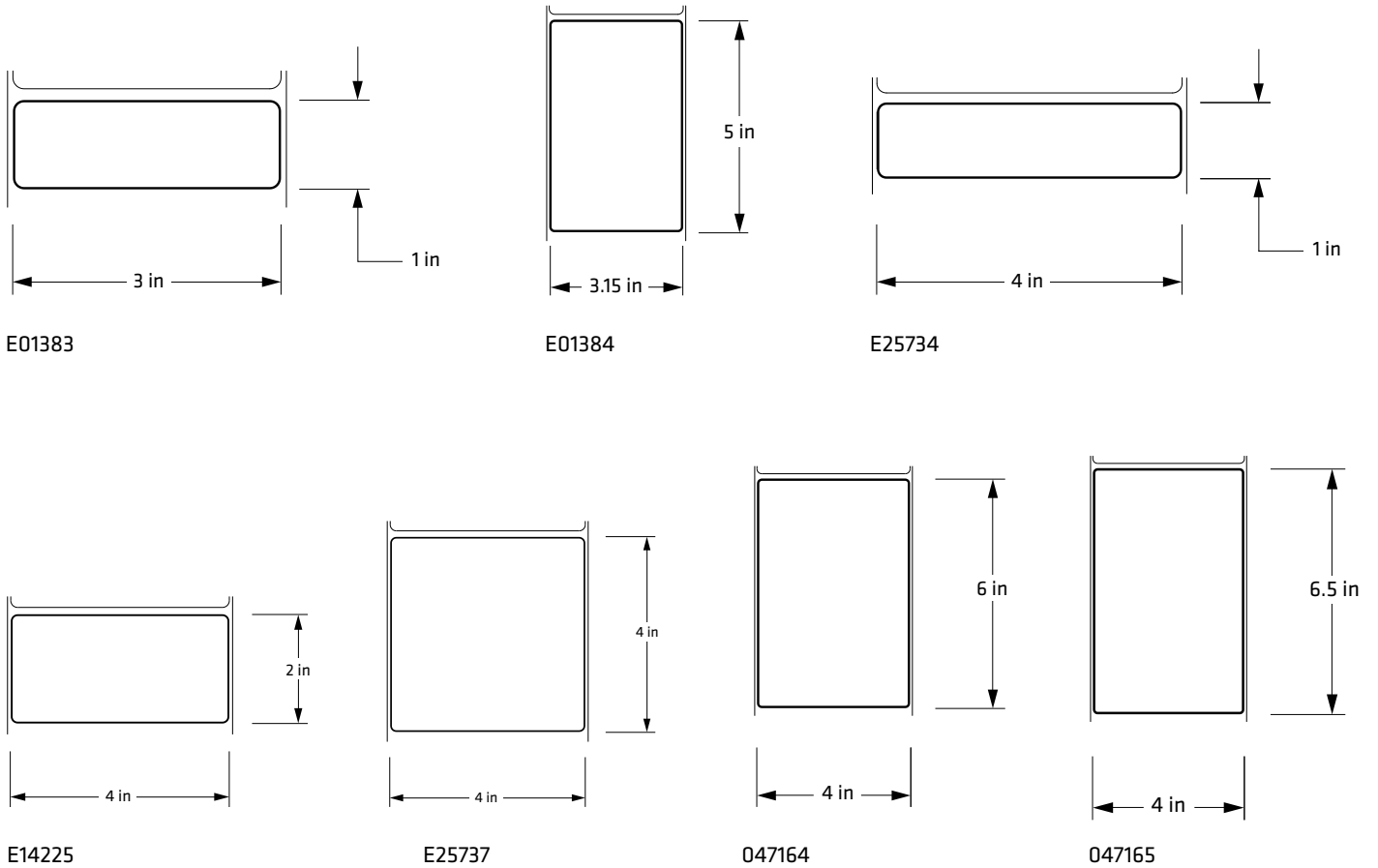

Size	ID	OD	Part Number	Qty/Roll	Rolls/Ctn	Ctn Weight	Stock/MTO	Suggested Retail Price \$/Roll	\$/M
3" x 1"	3"	8.38"	E01383	5,333	4	18	Stock	\$33.13	\$6.21
3.15" x 5"	3"	8.38"	E01384	1,170	4	19	Stock	\$26.03	\$22.25
4" x 1"	3"	8.38"	E25734	5,333	4	25	MTO	\$39.13	\$7.34
4" x 2"	3"	8.38"	E14225	2,823	8	47	Stock	\$44.18	\$15.65
4" x 4"	3"	8.38"	E25737	1,454	4	25	MTO	\$39.15	\$26.93
4" x 6"	3"	8.38"	047164	979	4	24	Stock	\$44.17	\$45.12
4" x 6.5"	3"	8.38"	047165	905	4	24	Stock	\$44.17	\$48.81



MEDIA FOR INDUSTRIAL PRINTERS

Duratherm II Tag

Duratherm II Tag is a 7-mil non top-coated direct thermal paper that offers high quality, cost-effective printing. This material is recommended for most general-use applications where exposure to chemicals and moisture is not anticipated.

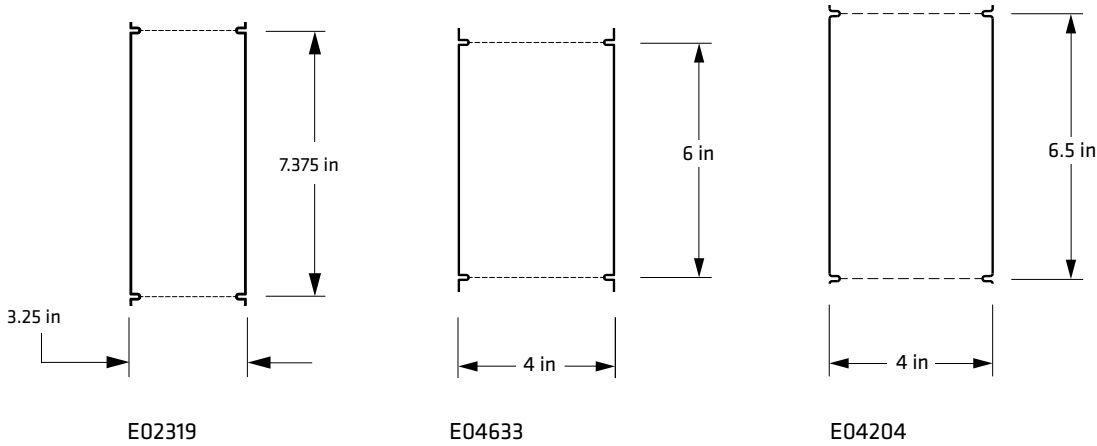

Size	ID	OD	Part Number	Qty/Roll	Rolls/Ctn	Ctn Weight	Stock/MTO	Suggested Retail Price \$/Roll	\$/M
3.25" x 7.375"	3"	8.38"	E02319	813	4	20	Stock	\$31.15	\$38.32
4" x 6"	3"	8.38"	E04633	1,000	4	24	Stock	\$38.35	\$38.35
4" x 6.5"	3"	8.38"	E04204	923	8	24	Stock	\$38.35	\$41.55



MEDIA FOR INDUSTRIAL PRINTERS

Duratherm III Labels

Duratherm III is a top-coated direct thermal paper that provides enhanced durability for applications where humidity and surface abrasion are a concern. Permanent adhesive.

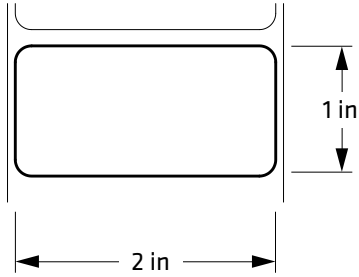

E22751

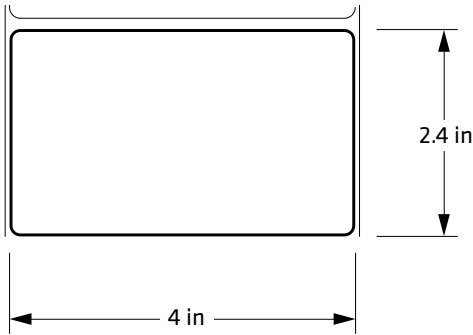

E06143

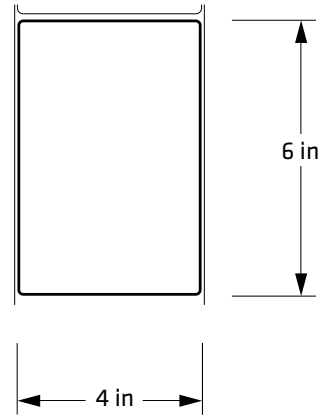

E06144

Width	ID	OD	Part Number	Qty/Roll	Rolls/Ctn	Ctn Weight	Stock/ MTO	Suggested Retail Price \$/Roll	\$/M
2" x 1"	3	8.38	E22751	4363	8	22	Stock	\$23.51	\$5.39
4" x 2.4"	3	8.38	E06143	2400	4	23	Stock	\$51.12	\$21.30
4" x 6"	3	8.38	E06144	979	4	23	Stock	\$46.37	\$47.36

MEDIA FOR INDUSTRIAL PRINTERS

Duratran II Labels

Duratran™ II is a top-coated thermal transfer paper that demonstrates excellent print quality with the TMX1407 ribbon. This product is recommended where moderate abrasion, heat or sunlight are present. Permanent adhesive.

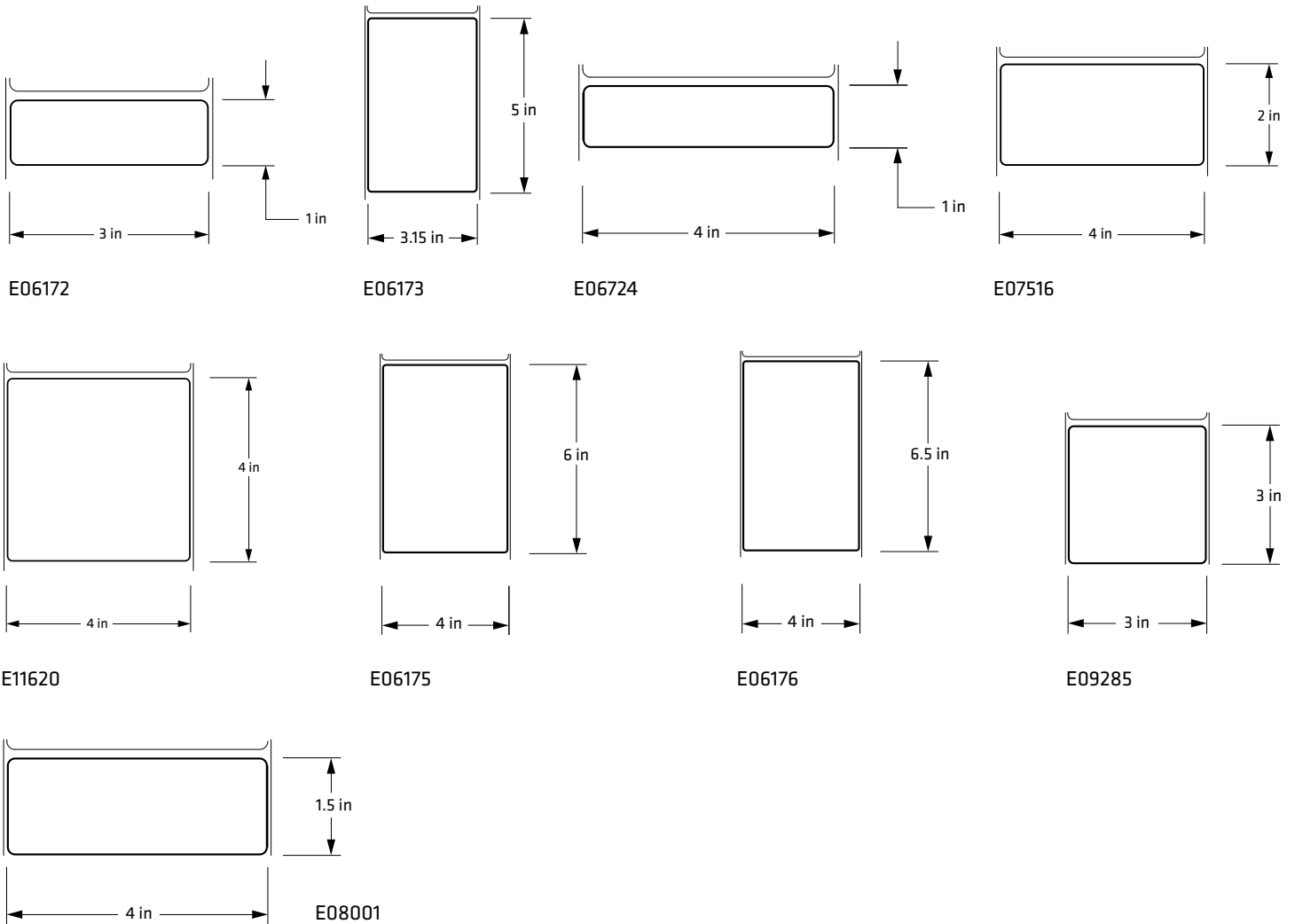

Size	ID	OD	Part Number	Qty/Roll	Rolls/Ctn	Ctn Weight	Stock/MTO	Suggested Retail Price \$/Roll	\$/M	PD/PM/PX Ribbon
3" x 1"	3"	8.38"	E06172	5,333	4	20	Stock	\$25.84	\$4.85	11233018
3.15" x 5"	3"	8.38"	E06173	1,170	4	21	Stock	\$20.45	\$17.48	11234118
3" x 3"	3"	8.38"	E09285	1,920	4	20	Stock	\$25.84	\$13.46	11234118
4" x 1"	3"	8.38"	E06724	5,333	8	48	Stock	\$34.45	\$6.46	11234118
4" x 1.5"	3"	8.38"	E08001	3,692	4	24	Stock	\$34.45	\$9.33	11234118
4" x 2"	3"	8.38"	E07516	2,823	4	24	Stock	\$25.98	\$9.20	11234118
4" x 4"	3"	8.38"	E11620	1,454	4	25	Stock	\$25.98	\$17.87	11234118
4" x 6"	3"	8.38"	E06175	979	4	24	Stock	\$32.79	\$33.49	11234118
4" x 6.5"	3"	8.38"	E06176	905	4	24	Stock	\$32.79	\$36.23	11234118



MEDIA FOR INDUSTRIAL PRINTERS

Duratran II Floodcoated Labels

Duratran™ II Floodcoated Labels are pre-printed with a scanner-friendly solid color that demonstrates excellent print quality with the TMX1407 ribbon. This product is recommended where moderate abrasion, heat or sunlight are present. Permanent adhesive.

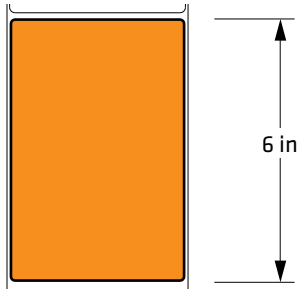

E07267-PMS021

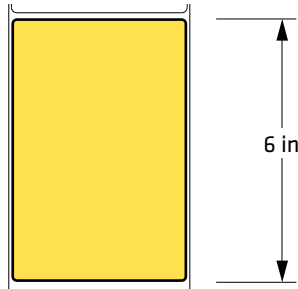

E07267-PMS115

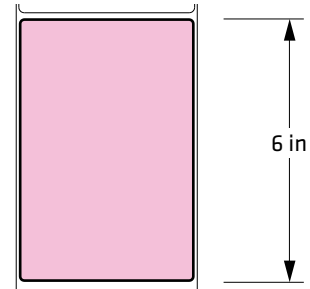

E07267-PMS236

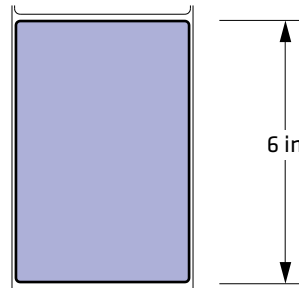

E07267-PMS2707

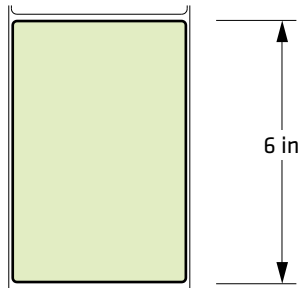

E07267-PMS365

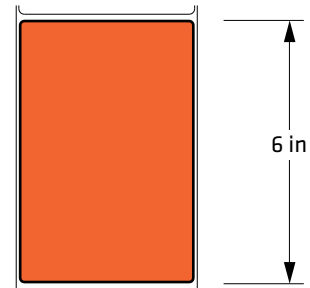

E07267-PMSWMRED

Size	ID	OD	Part Number	Qty/Roll	Rolls/Ctn	Ctn Weight	Stock/ MTO	Suggested Retail Price		PD/PM/PX Ribbon
								\$/Roll	\$/M	
4" x 6"	3"	8.38"	E07267-PMS021	979	4	24	Stock	\$34.35	\$35.08	11234118
4" x 6"	3"	8.38"	E07267-PMS115	979	4	24	Stock	\$34.35	\$35.08	11234118
4" x 6"	3"	8.38"	E07267-PMS236	979	4	24	Stock	\$34.35	\$35.08	11234118
4" x 6"	3"	8.38"	E07267-PMS2707	979	4	24	Stock	\$34.35	\$35.08	11234118
4" x 6"	3"	8.38"	E07267-PMS365	979	4	24	Stock	\$34.35	\$35.08	11234118
4" x 6"	3"	8.38"	E07267-PMSWMRED	979	4	24	Stock	\$34.35	\$35.08	11234118



MEDIA FOR INDUSTRIAL PRINTERS

Duratran II Tags

Duratran II Tag is a 7-mil top-coated thermal transfer tag that demonstrates excellent print quality with the TMX1407 ribbon. This product is recommended where moderate abrasion, heat or sunlight are present.

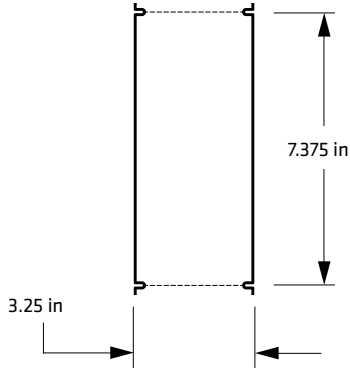

E04891

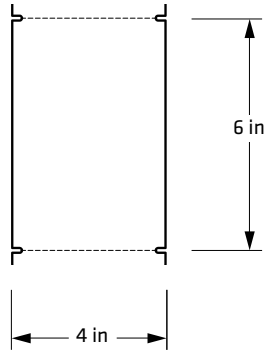

E09708

Size	ID	OD	Part Number	Qty/Roll	Rolls/Ctn	Ctn Weight	Stock/ MTO	Suggested Retail Price \$/Roll	\$/M	PD/PM/PX Ribbon
3.25" x 7.375"	3"	8.38"	E04891	813	8	41	Stock	\$29.35	\$36.10	11234118
4" x 6"	3"	8.38"	E09708	1,000	4	25	Stock	\$36.12	\$36.12	11234118

MEDIA FOR INDUSTRIAL PRINTERS

Duratran II Kimdura Film Labels

A durable, high-quality polyolefin thermal transfer label. Exhibits good tear resistance and moisture resistance, as well as moderate temperature and chemical resistance. Demonstrates excellent print quality when printed with the TMX2202 Mid-Range ribbon.

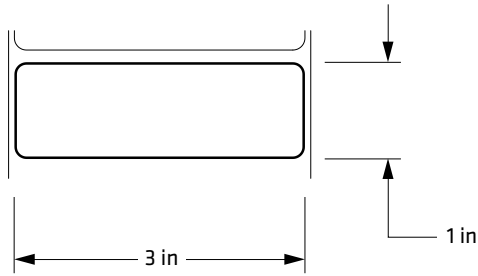

E02202

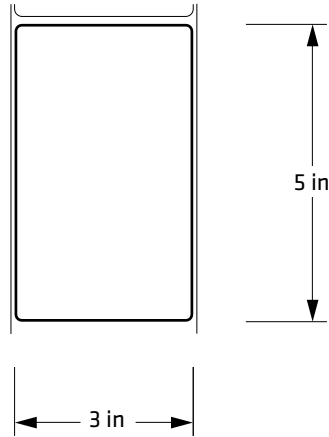

E02203

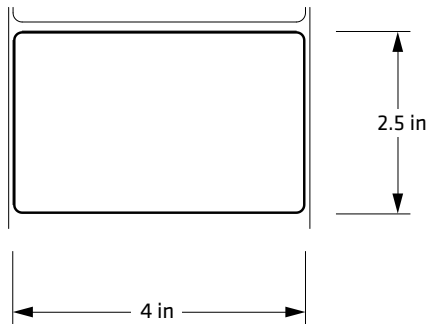

E02204

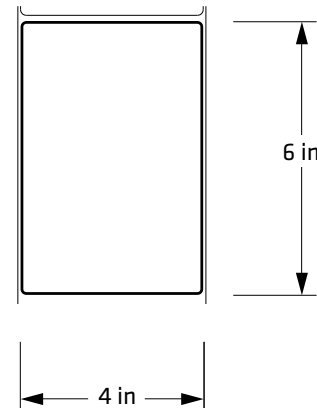

E03444

Size	ID	OD	Part Number	Qty/Roll	Rolls/Ctn	Ctn Weight	Stock/ MTO	Suggested Retail Price \$/Roll	\$/M	PD/PM/PX Ribbon
3" x 1"	3"	8.38"	E02202	4,888	8	38	Stock	\$49.04	\$10.03	12033118
3" x 5"	3"	8.38"	E02203	1,073	8	38	Stock	\$49.04	\$45.70	12033118
4" x 2.5"	3"	8.38"	E02204	2,095	4	26	Stock	\$65.37	\$31.20	12234118
4" x 6"	3"	8.38"	E03444	897	4	26	Stock	\$65.37	\$72.88	12234118



MEDIA FOR INDUSTRIAL PRINTERS

Duratran II Valeron Film Tags

A premium performance polyethylene tag with excellent tear resistance. Excellent choice when attaching with thin gauge wire or when staples are used. Demonstrates excellent print quality when printed with the TMX2202 Mid-Range ribbon.

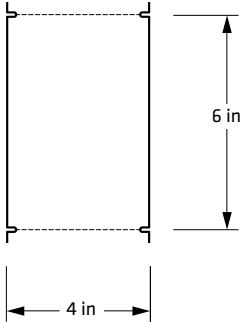

E12982

Size	ID	OD	Part Number	Qty/Roll	Rolls/Ctn	Ctn Weight	Stock/ MTO	Suggested Retail Price \$/Roll	\$/M	PD/PM/PX Ribbon
4" x 6"	3"	8.38"	E12982	916	4	26	Stock	\$78.58	\$85.79	12234118

Duratran II Gloss Polyester Labels

A high-gloss, top-coated polyester label with exceptional print quality. Excellent tear, smear and abrasion resistance; highly moisture and heat resistant. Product is UL recognized when printed with Intermec TMX3202 ribbons. High-tack adhesive.

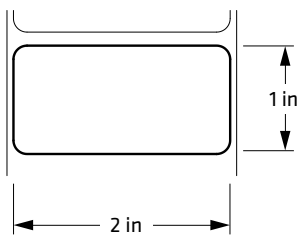

E10164

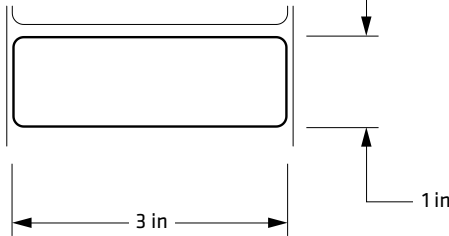

E23068

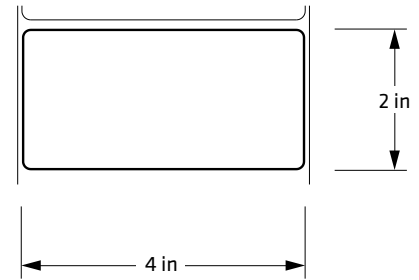

E23222

Size	ID	OD	Part Number	Qty/Roll	Rolls/Ctn	Ctn Weight	Stock/ MTO	Suggested Retail Price \$/Roll	\$/M	PD/PM/PX Ribbon
2" x 1"	3"	8.38"	E10164	5,333	8	25	Stock	\$57.05	\$10.70	13632018
3" x 1"	3"	8.38"	E23068	5,333	4	19	Stock	\$85.57	\$16.05	13633018
4" x 2"	3"	8.38"	E23222	3,000	8	51	Stock	\$114.09	\$38.03	13634118



MEDIA FOR INDUSTRIAL PRINTERS

ThermaMAX 1000 Wax Ribbons

A general-purpose, smear-resistant wax ribbon providing good durability when printing on Duratran™ II Papers and Tags.

Width	Length	Part Number	Qty/Ctn	Ctn Weight	Stock/ MTO	Wind	Suggested Retail Price		Printer
							\$/Roll	\$/Carton	
2"	18024"	11232018	36	22	Stock	CSI	\$12.17	\$438.12	PD/PM/PX4i
3"	6000"	11023006	12	7	Stock	CSO	\$9.94	\$119.28	3400
3"	18024"	11233018	24	30	Stock	CSI	\$18.26	\$438.24	PD/PM/PX
4.1"	6,000"	11084106	12	6	Stock	CSO	\$13.58	\$162.96	3400
4.1"	18024"	11234118	24	27	Stock	CSI	\$24.61	\$590.64	PD/PM/PX
4.1"	18,000"	11064118	12	14	Stock	CSO	\$33.10	\$397.20	4420

ThermaMAX 2000 Mid-Range Ribbons

A mid-range ribbon that provides enhanced abrasion/smear resistance and high image quality when used with Duratran II coated papers and across the Intermec Mid-Range Film product line.

Width	Length	Part Number	Qty/Ctn	Ctn Weight	Stock/ MTO	Wind	Suggested Retail Price		Printer
							\$/Roll	\$/Carton	
2"	18024"	12232018	24	22	Stock	CSI	\$22.77	\$546.48	PD/PM/PX4i
2.09"	6000"	12022006	18	6	Stock	CSO	\$8.97	\$161.46	3240/3400
3"	6000"	12023006	18	7	Stock	CSO	\$13.46	\$242.28	3400
3.15"	18000"	12033118	24	22	Stock	CSI	\$35.87	\$860.68	PD/PM/PX
4.1"	6,000"	12084106	12	7	Stock	CSO	\$18.39	\$220.68	3400
4.1"	18024"	12234118	12	27	Stock	CSI	\$46.68	\$560.16	PD/PM/PX
4.1"	18,000"	12064118	12	14	Stock	CSO	\$46.68	\$560.16	4420

ThermaMAX 3000 Resin Ribbons

A high quality resin ribbon for applications that require the optimum level of smear and abrasion resistance. Excellent imaging and performance across the Intermec Ultra-Durable Film product line. UL Recognized when used with Intermec Duratran II Gloss Polyester Labels.

Width	Length	Part Number	Qty/Ctn	Ctn Weight	Stock/ MTO	Wind	Suggested Retail Price		Printer
							\$/Roll	\$/Carton	
2.1"	18036"	13632018	24	12	Stock	CSI	\$32.81	\$787.44	PD/PM/PX4i
3"	6000"	13023006	36	17	Stock	CSO	\$22.18	\$798.48	3400
3"	18036"	13633018	24	18	Stock	CSI	\$49.22	\$1,181.28	PD/PM/PX
4.1"	6,000"	13084106	24	12	Stock	CSO	\$30.31	\$727.44	3400
4.1"	18036"	13634118	24	24	Stock	CSI	\$68.19	\$1,636.56	PD/PM/PX
4.1"	18,000"	13064118	24	27	Stock	CSO	\$67.27	\$1,614.24	4420



APPENDIX

Direct Thermal vs. Thermal Transfer

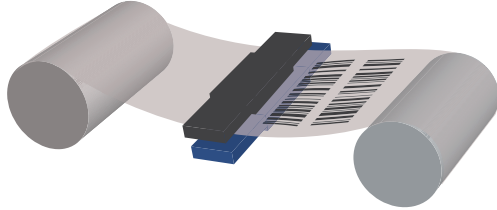

Direct Thermal Media Explained

Direct Thermal media uses a transparent heat-sensitive coating applied to its surface to image text and bar codes. When the heat from the print head contacts the coating, it initiates a chemical reaction that turns the coating black.

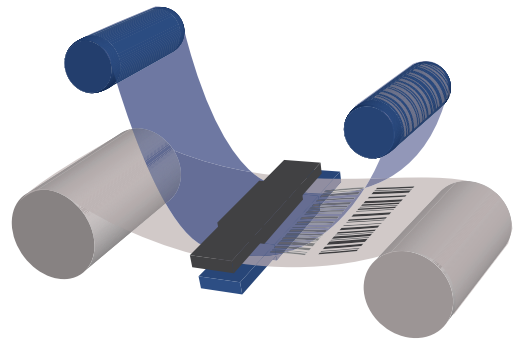

Thermal Transfer Media Explained

Thermal Transfer media uses a ribbon to image the text and bar codes on a variety of materials, both paper and film. When the ribbon is passed beneath the print head, the heat softens the ribbon ink while in contact with the label or tag, resulting in the transfer of the ink to the surface of the label or tag. There are three general classes of ribbons that are used in thermal printers: Wax, Mid-range, and Resin.

Wax ribbons are the most commonly used class and are mostly targeted to print paper labels and tags that will be exposed to relatively benign environments. Wax ribbons are also used to print on film labels and tags in some applications.

Mid-range ribbons are a hybrid design where resin is mixed with the wax to produce ribbons with durability properties that fall somewhere between the wax and resin ribbons. Mid-range ribbons are used to print on both paper and film labels and tags.

Resin ribbons are the most durable and are mostly targeted to printing on film labels and tags that will be exposed to extreme environments.

Ask about Intermec's

Free Printhead Replacement Program*

- Provides no-cost printhead replacement for all Intermec fixed printers
- Lowers total cost of ownership, speeds up return on investment
- Applies to all Intermec media supplies

*Conditions apply. See www.intermec.com



 **Your Logo Here**

Company Name
123 Your Street
City, State Zip
123.456.7890
info@YourURL.com
www.YourURL.com

 **Intermec**
PartnerNet

Copyright © 2012 Intermec Technologies Corporation. All rights reserved. Intermec is a registered trademark of Intermec Technologies Corporation. All other trademarks are the property of their respective owners. Printed in the U.S.A. 612168-04/12

In a continuing effort to improve our products, Intermec Technologies Corporation reserves the right to change specifications and features without prior notice.